

Development and Testing of HTP Monopropellant Thruster for Space Applications

Dror Nissan

University of Padova

Centro di Ateneo degli Studi e Attivita Spaziali "Giuseppe Colombo"



September 11th 2020



Introduction to Monopropellant Thrusters

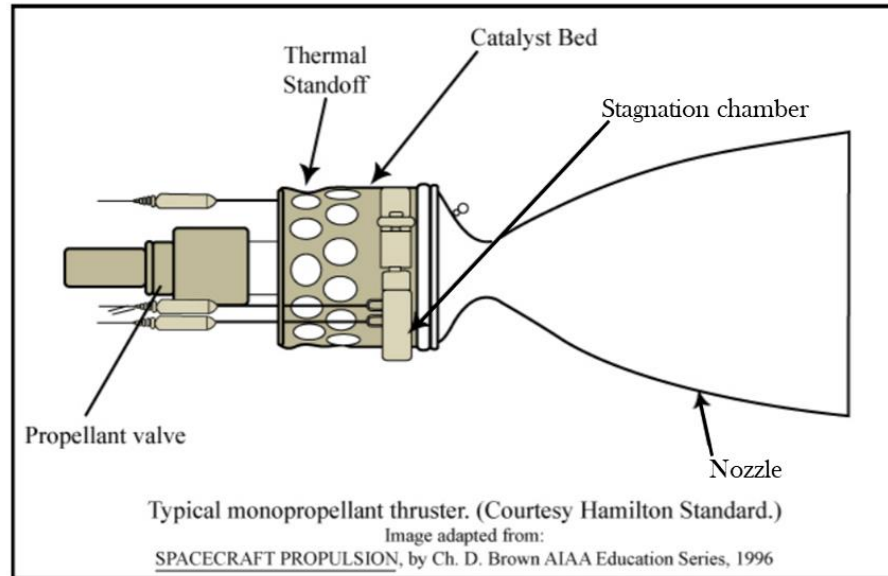

- Single propellant flows through a catalyst bed
- Exothermic decomposition of the propellant creates hot gas mixture
- The decomposition products are exhausted through the nozzle to obtain thrust
- Conventional propellant – Hydrazine (N_2H_4)



Main Characteristics & Applications

- Relatively low decomposition temperature $\approx 760^{\circ}\text{C}$
- No thermal protection
 - \Rightarrow **Simple motor structure**
- Stop and restart capability
 - \Rightarrow **Operational versatility**



**RCS for micro-launcher
upper stage**

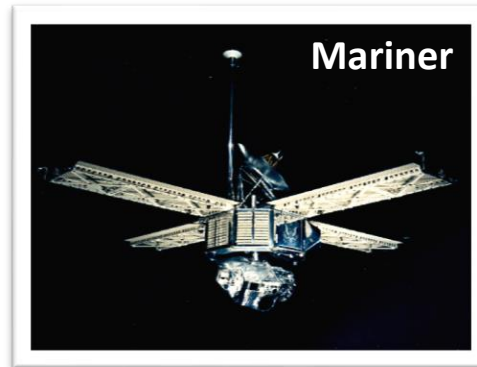

**Satellites or space vehicles
maneuvering and de-orbiting**



Why HTP?

HTP (High Test Peroxide), concentration > 80%

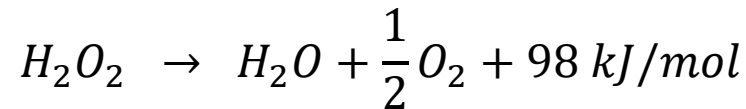

- “Green” propellant, reduced pollution and toxicity
 - Safety during handling, manufacturing and testing
 - Storable at room temperature
- ⇒ **Low operative cost**

- High volumetric specific impulse
- ⇒ **Compatible for space applications**

In this research, the goal is to improve TRL of HTP monopropellant thruster

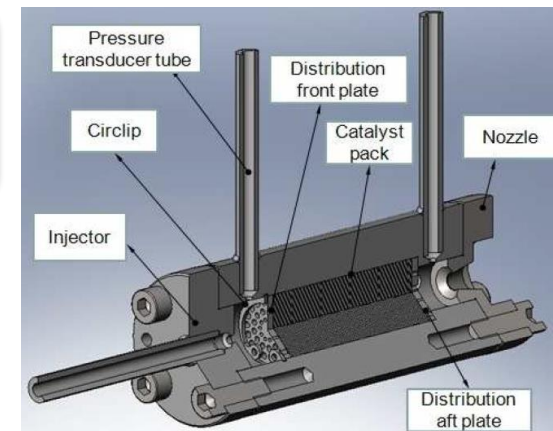

Current Work – Review

- Motor design
- CFD investigation of channeling phenomena
- Thermal analysis of the nozzle
- Structural analysis
- Implementation of the fuel feeding line for the experimental set-up
 - Cavitating venturi
 - Fast Response Valve for Pulse Mode Operation
- Propulsion system performance analysis

Motor Design

Main Characteristics:

- Additive Manufacturing (3D print)
- Minimum Components
- Multiple Configurations
- Weight Optimization $\approx 90\text{gr}$

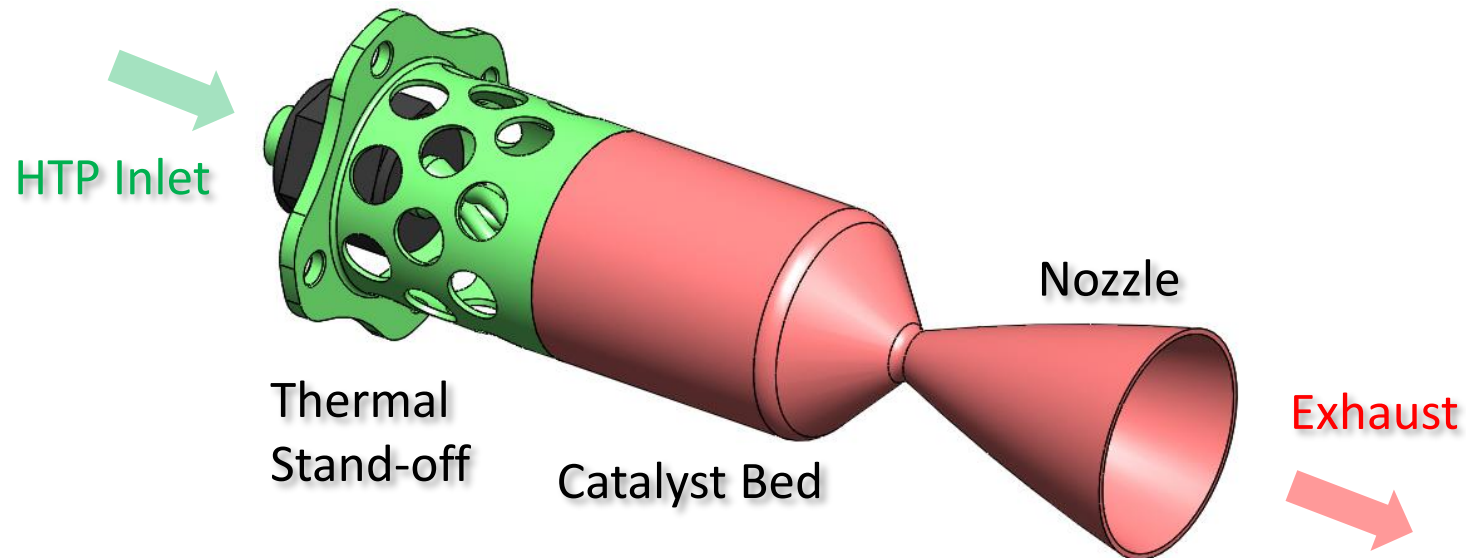

Anti-Channeling Feature

Channeling:

- By-pass of liquid HTP near the wall
- Decomposition efficiency is decreased

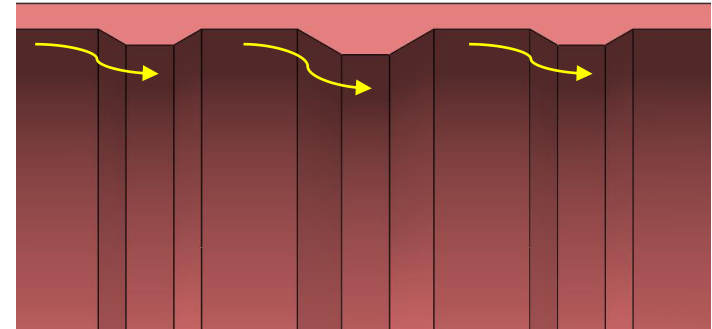

Suggested Solution:

- Disturbance to the near-wall flow
- Preventing a by-pass flow
- Directing the fluid through the bulk catalyst
- CFD investigation leads to selected design

Anti-Channeling Feature

- 2D RANS Simulation
- Axisymmetric Model
- Steady-State
- Fluid: Liquid HTP
- Laminar Flow

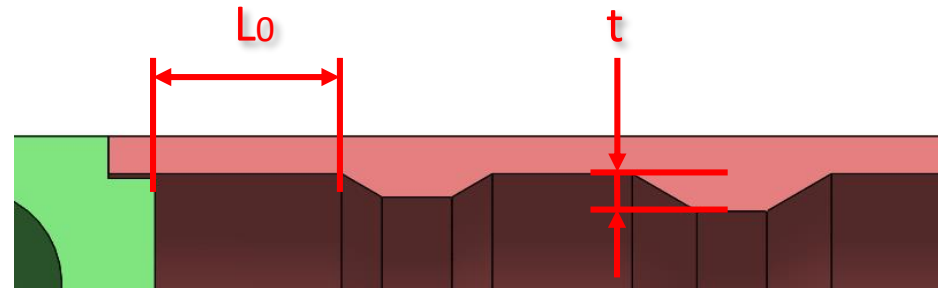

n = number of disturbances

Preliminary results:

- Boundary layer thickness increase
- Outlet mass flow at 1mm distance from the wall decrease $\approx 40\%$

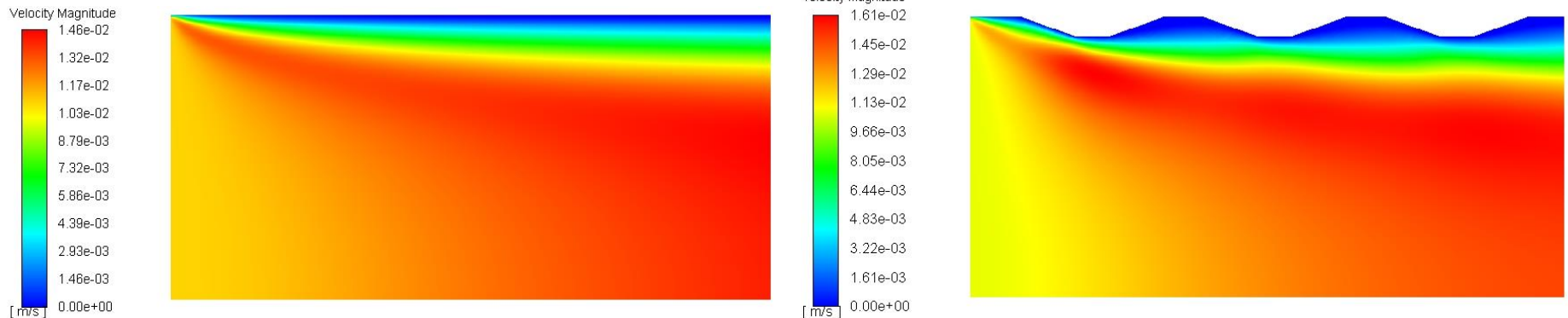

Thermal Analysis of The Nozzle

- 2D RANS Simulation
- Steady-State
- Fluid: HTP decomposition products

Preliminary Results:

- Evaluation of Convection Rate $\approx 2.4 \text{ W/cm}^2$
- Coefficient Of Thermal Convection
- Low Temperature Gradient at the wall $< 5^\circ\text{C}$
- Low Thermal Stress

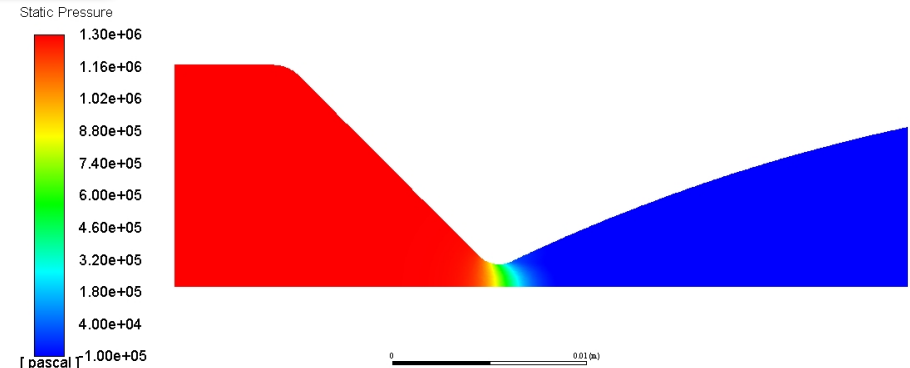
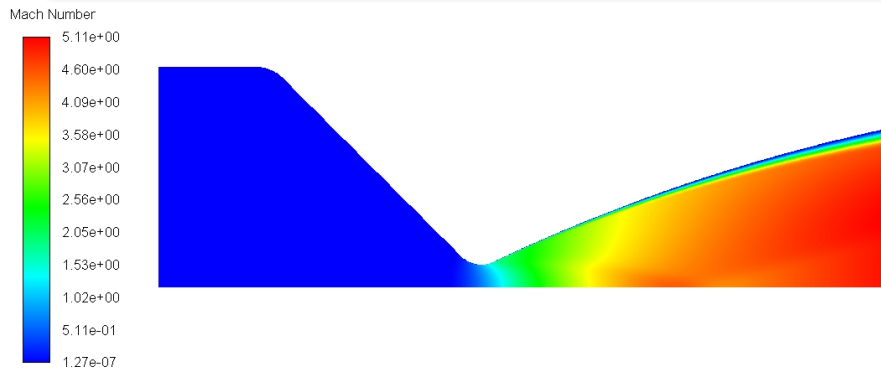
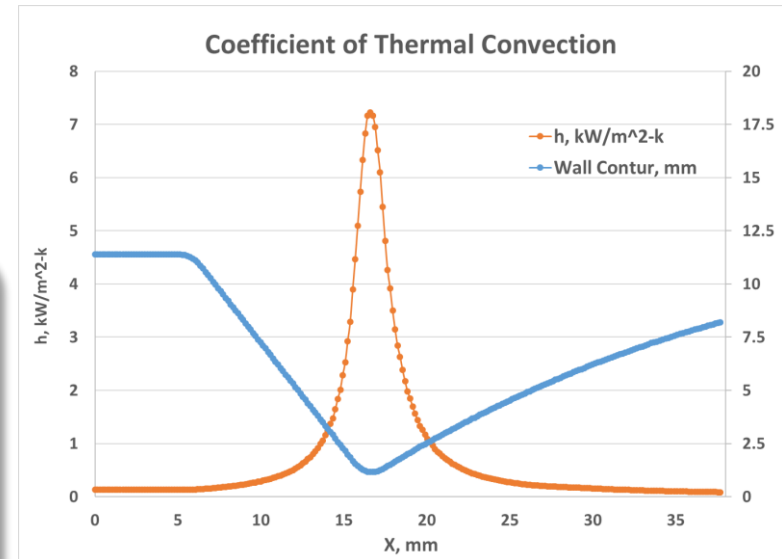

Structural Analysis

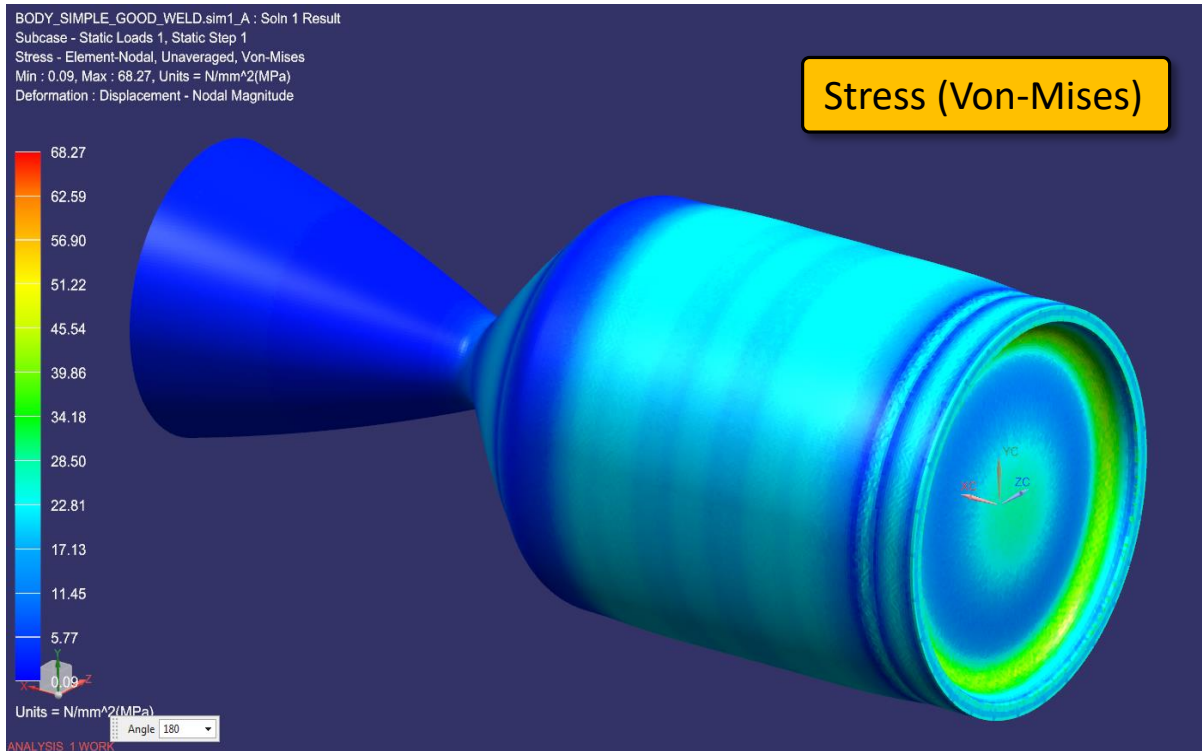

- Load Case: Max. Internal Pressure
- High Safety Factor

Cavitating Venturi

- Fixed cavitating venturi was manufactured and tested with water and HTP.
- Several CV's with different throat diameter.

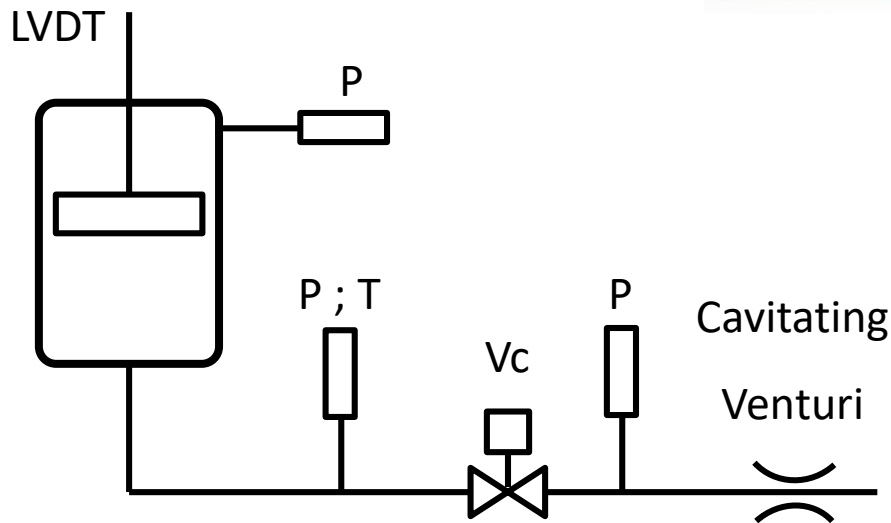
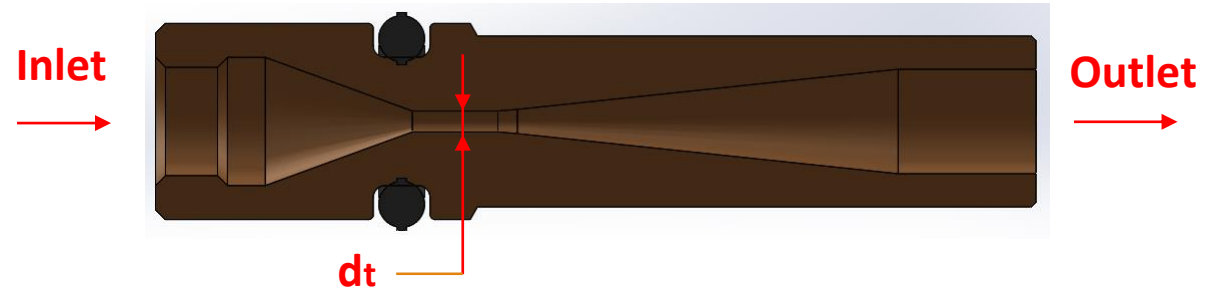

- Pressurized HTP tank
- LVDT – piston position --> mass flow
- Pneumatic valves
- Fixed throat cavitating venturi

Cavitating Venturi

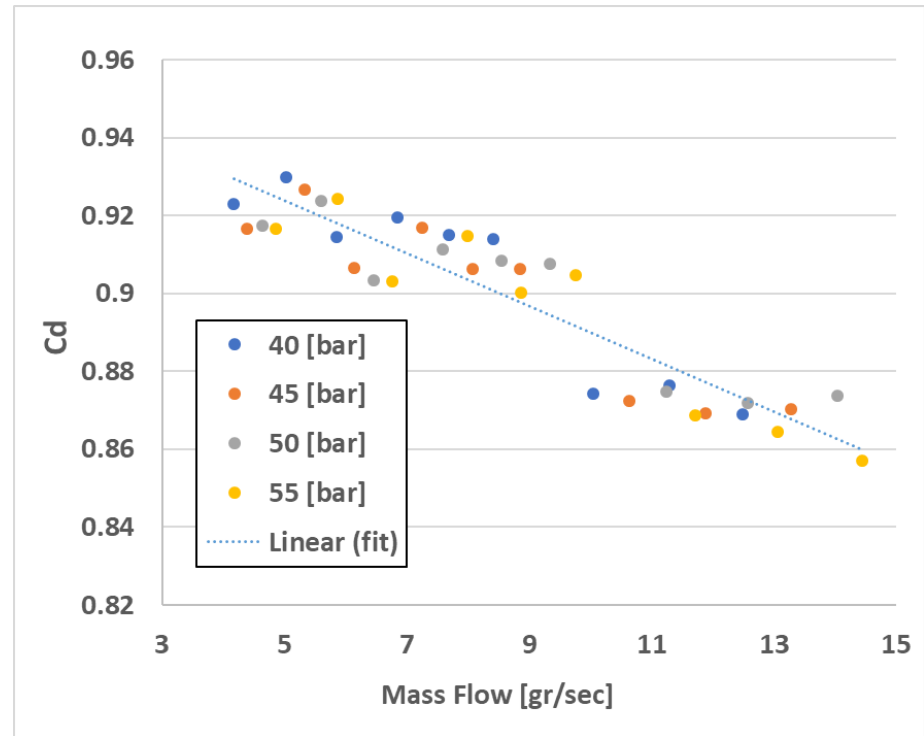
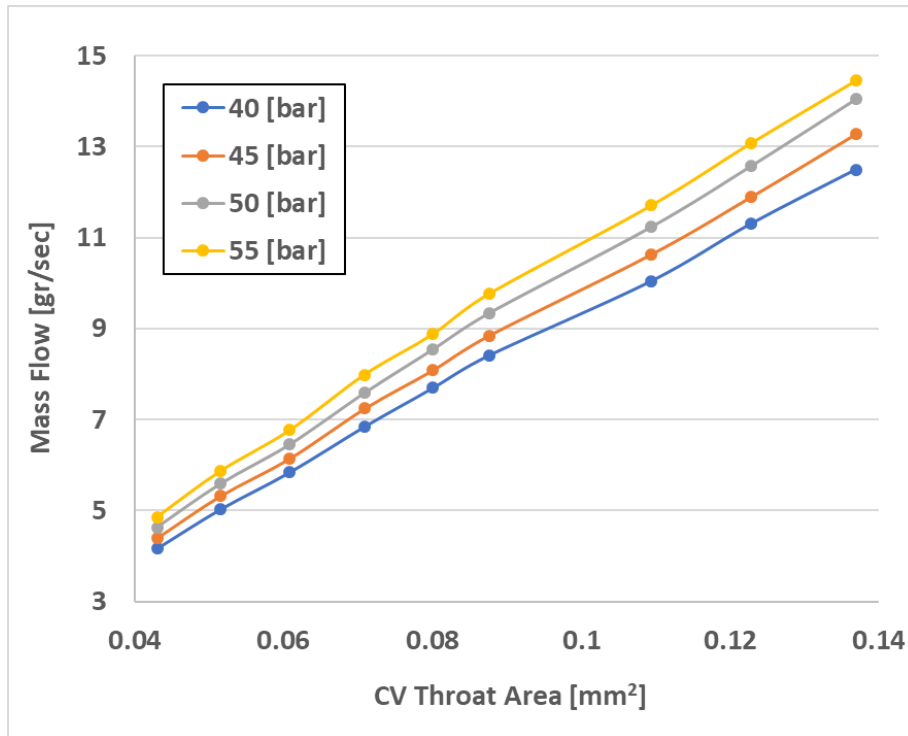

Fast Response Valve For Pulse Testing

- Valve characteristics:
 - Response time – 12 msec to open ; 5 msec to close
- **Suitable for pulse testing**
- Minimum opening voltage – 16V
- Current draw – 2A
- HTP compatibility test:
 - 24hr exposure
 - No leakage detected
 - No degradation in valve performance
(sealing, response time, current draw, etc.)

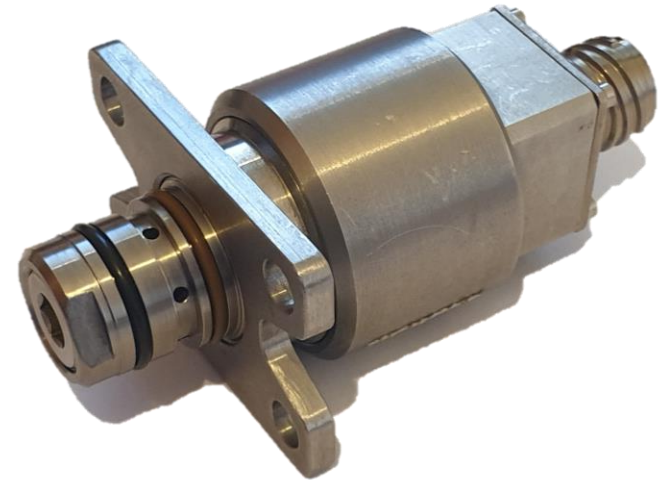

Propulsion System Performance Analysis

- Propulsion system design based on HTP thrusters
- Modeling with commercial software
- Useful tool for system design and optimization:
 - Pressure drop in feeding lines
 - Minimum components
 - Minimum failure modes
 - Weight and Volume
 - Simplicity and Reliability

Future Work

- Injector testing with water and HTP
- Motor assembly
- Fire test campaign
- Analysis of motor performance
- Propulsion system design
 - Validation of simulation according to fire tests results
 - Analysis of system considerations

Test Facility

Equipped Test Facility

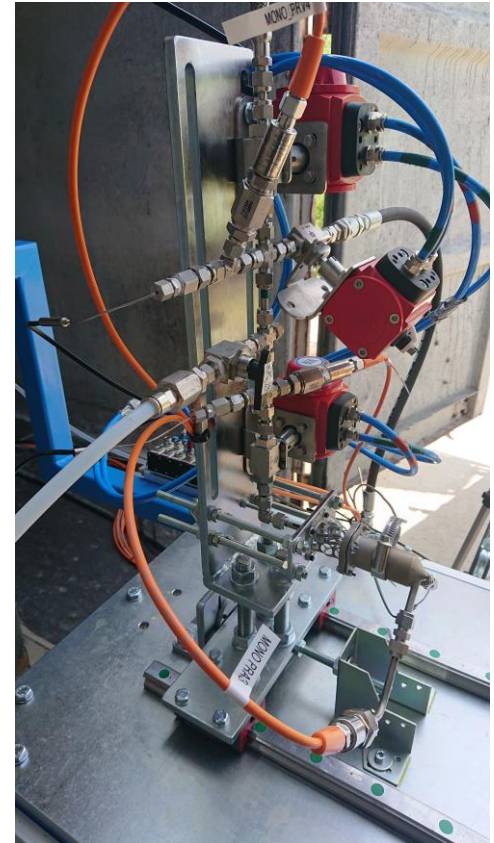

Test Bed

PhD Activity

Level	Work Package	Hours	1st Year				2nd Year				3rd Year				
1.0	Bibliographic Research	210	150	60											
1.1	State of the Art Research	70	70												
1.2	Methods of Numerical Analysis	70	40	30											
1.3	Methods of Experimental Analysis	70	40	30											
2.0	Numerical Investigation	1200	150	250	330	270	200								
2.1	Motor Design	150	100	50											
2.2	Injector Design	150	50	100											
2.3	Thermal Analysis	150		100	50										
2.4	Test Matrix	350			200	150									
2.5	Data Analysis	300			80	120	100								
2.6	Numerical Correlation	100					100								
3.0	Experimental Activity	850					100	350	300	100					
3.1	Experimental Set-up	250					100	150							
3.2	Test Matrix	300						150	200						
3.3	Data Analysis and Validation	150						50	100						
3.4	Experimental Correlation	100								100					
4.0	Propulsion System Design	800								200	350	250			
4.1	Definition of System Configurations	100								100					
4.2	System Modeling and Simulation	150								100	50				
4.3	Test matrix	300									300				
4.4	Data Analysis and Validation	250										250			
5.0	Exploitation	100												100	
5.1	Spacecraft / Satellite Attitude Control and main propulsion system	50												50	
5.2	Engine Comparison / Market Analysis	50												50	
6.0	Thesis and Documentation	600				50				50			100	200	200
	Total Hours	3760				1260				1300				1200	

Thank you for your attention

Any questions?